

FOAM RATIO CONTROLLER (Between Flange)

# HARDWARE



## Features

*Compatible with all type foam concentrates*

*Fresh or saltwater use*

*Proportions at 1%, 3% or 6%*

*Vertical or horizontal position for installation versatility*

*Bronze construction for durability and performance*



## Description

SOLBERG® Ratio Controllers are modified venturi devices designed to meter the correct amount of foam concentrate into a water stream over a specified range of flow and pressure rates with minimal pressure loss. The ratio controller consists of three components: the body with water inlet, metering orifice located in the foam concentrate inlet, and throat (nozzle) located downstream from the water inlet. The ratio controller is manufactured in four sizes 3.0", 4.0", 6.0" and 8.0" (76 mm, 102 mm, 152 mm, 203 mm).

## Application

SOLBERG® Ratio Controllers are commonly used in bladder tank systems, balanced or inline balanced\* pressure proportioning systems for aircraft hangars, loading racks, tank farms, and foam-water sprinkler systems.

## Specifications

The SOLBERG Ratio Controller is designed for installation between two Class 150 flanges of the same nominal size as the ratio controller. The components are constructed of ASTM 85-5-5-5 bronze and the inlet is tapered and machined to a smooth finish to maximize water

stream efficiency. The inlet nozzle and metering orifice are secured by a stainless steel retaining ring. The foam concentrate inlet has a female NPT thread and contains a foam concentrate metering orifice to proportion over the specified flow range without any manual adjustment. The SOLBERG Foam Ratio Controller is to be installed with a minimum of 5 pipe diameters of straight pipe both upstream and downstream of the proportioner.

## Certifications

Underwriters Laboratories, Inc. (UL) Listed – Standard 162, FM Approved per Approval Standard 5130.

*\*Not an FM Approved Configuration*

***SOLBERG is a member of PERIMETER SOLUTIONS, a global producer of leading fire retardant, gel and foam brands with a singular purpose: revolutionize the course of fire suppression technology with safer, more effective and more sustainable solutions. Together, we are Moving Industries Forward by Redefining Fire Suppression. [www.solbergfoam.com](http://www.solbergfoam.com)***

**Dimensional Information**

MODEL	APPROXIMATE DIMENSIONS Inches (Millimeters)						STANDARD CONCENTRATE LINE SIZES
	A	B	C	D	E	F	
3.0" SRCW	1.25 (32)	2.38 (60)	2.63 (67)	1.25 (32)	3.75 (95)	6.13 (156)	1.25
4.0" SRCW	1.50 (38)	2.63 (67)	3.38 (86)	1.31 (33)	5.38 (137)	8.00 (203)	1.50
6.0" SRCW	2.00 (51)	3.25 (83)	4.25 (108)	1.63 (41)	8.75 (222)	12.00 (305)	2.00
8.0" SRCW	2.50 (64)	3.50 (89)	5.25 (133)	1.75 (44)	8.50 (216)	12.00 (305)	2.50

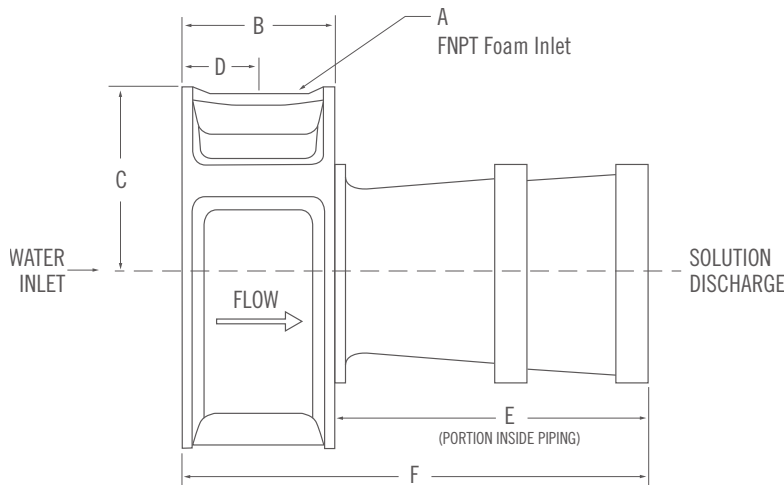

*Note: 1% 3% or 6% proportioning and type of foam concentrate to be specified by customer.*

**Flow Range**

**UL LISTED - NOMINAL FLOW**

MODEL	CONFIGURATION	RE-HEALING RF3, 3% gpm (lpm)	ARCTIC 1% SP AFFF gpm (lpm)	ARCTIC 3% AFFF gpm (lpm)	ARCTIC 3% MIL-SPEC AFFF gpm (lpm)	ARCTIC 3x3% ATC gpm (lpm)
3.0" SRCW	Between Flange	423-689 (1601-2608)	78-736 (295-2786)	93-768 (352-2907)	96-550 (363-2082)	206-812 (780-3074)
4.0" SRCW	Between Flange	752-1257 (2847-4758)	140-1360 (530-5148)	207-1532 (784-5799)	210-1335 (795-5053)	329-1530 (1245-5792)
4.0" SRCW	Between Flange	595-1335 (2252-5054)				
6.0" SRCW	Between Flange	1019-1845 (3857-6984)	388-2830 (1469-10713)	318-2680 (1204-10145)	295-2250 (1117-8516)	736-2667 (2786-10096)
6.0" SRCW	Between Flange	1564-2027 (5920-7673)				
8.0" SRCW	Between Flange	1909-4718 (7223-17860)	630-4920 (2385-18624)	975-4355 (3691-16485)	975-4250 (3690-16086)	1670-4590 (6322-17375)

**FM APPROVED - NOMINAL FLOW**

MODEL	CONFIGURATION	RE-HEALING RF3, 3% gpm (lpm)	ARCTIC 3x3% ATC gpm (lpm)
3.0" SRCW	Between Flange	490-665 (1855-2517)	206-785 (780-2971)
4.0" SRCW	Between Flange	700-1215 (2650-4600)	238-1153 (900-4365)
6.0" SRCW	Between Flange	1310-1955 (4960-7552)	730-2245 (2763-8498)



### Pressure Loss Curves

UL LISTED  
NOMINAL FLOW RATES

RE-HEALING RF3, 3% FOAM CONCENTRATE

#### 3 Inch Ratio Controller

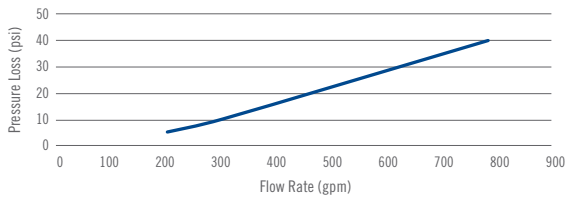

#### 4 Inch Ratio Controller

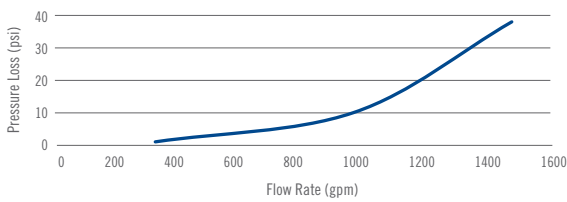

#### 6 Inch Ratio Controller

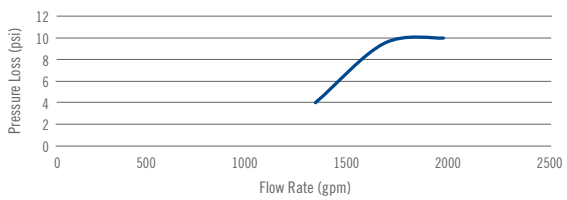

#### 8 Inch Ratio Controller

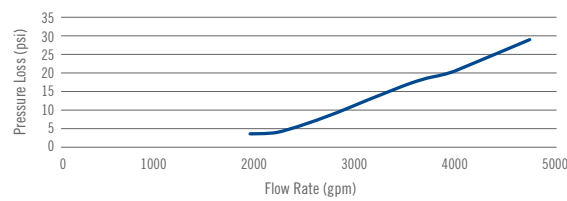

UL LISTED  
NOMINAL FLOW RATES

ARCTIC™ 1% SP FOAM CONCENTRATE

#### 3 Inch Ratio Controller

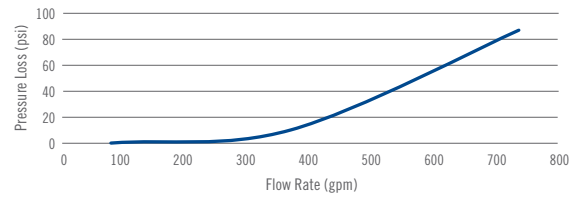

#### 4 Inch Ratio Controller

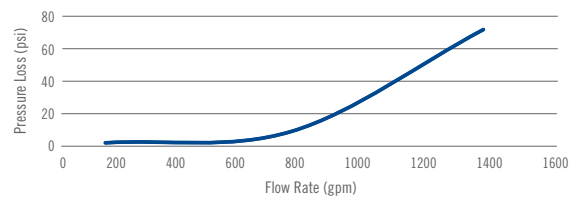

#### 6 Inch Ratio Controller

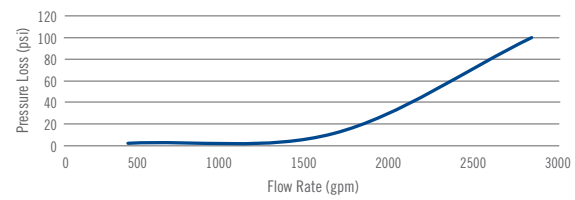

#### 8 Inch Ratio Controller

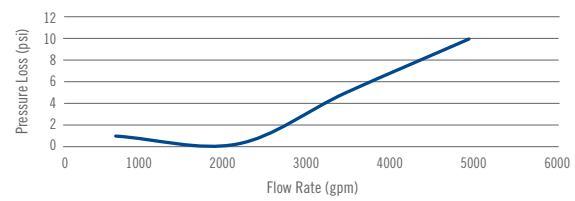



### Pressure Loss Curves

UL LISTED  
NOMINAL FLOW RATES

ARCTIC™ 1% AFFF FOAM CONCENTRATE

#### 4 Inch Ratio Controller

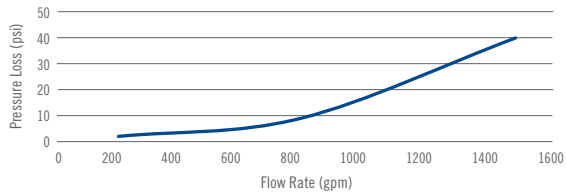

#### 6 Inch Ratio Controller

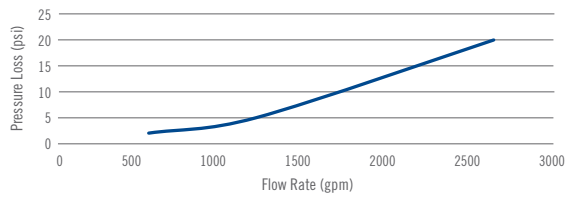

UL LISTED  
NOMINAL FLOW RATES

ARCTIC™ 3% AFFF FOAM CONCENTRATE

#### 3 Inch Ratio Controller

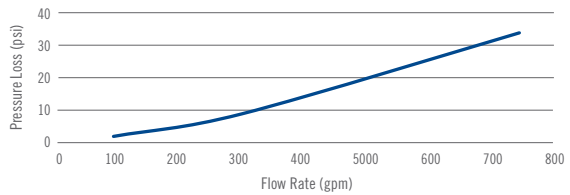

#### 4 Inch Ratio Controller

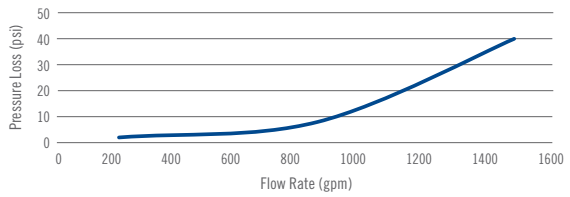

#### 6 Inch Ratio Controller

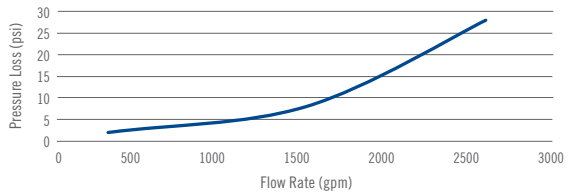

#### 8 Inch Ratio Controller

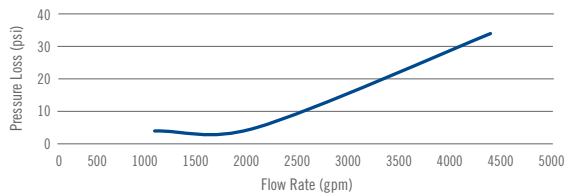



**Pressure Loss Curves**

**UL LISTED  
NOMINAL FLOW RATES**

**ARCTIC™ 3% MIL-SPEC FOAM CONCENTRATE**

**3 Inch Ratio Controller**

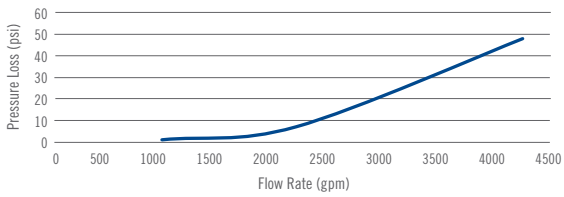

**4 Inch Ratio Controller**

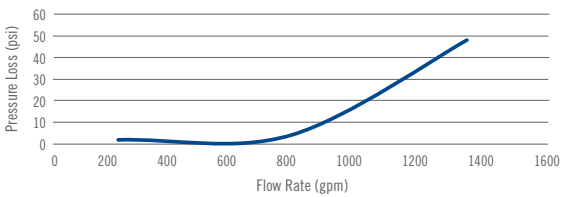

**6 Inch Ratio Controller**

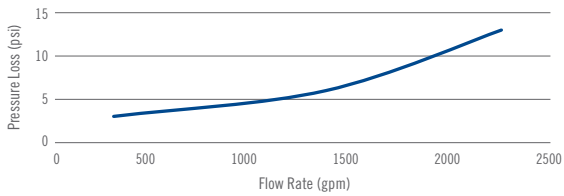

**8 Inch Ratio Controller**

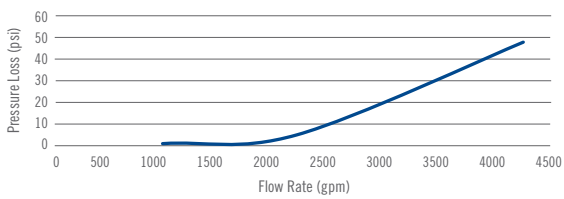

**UL LISTED  
NOMINAL FLOW RATES**

**ARCTIC™ 3X3% ATC™ FOAM CONCENTRATE**

**3 Inch Ratio Controller**

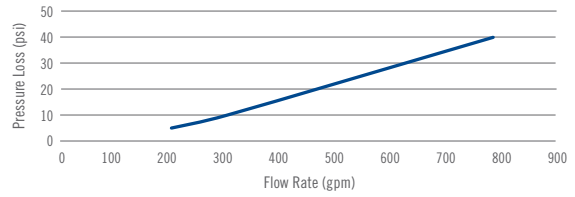

**4 Inch Ratio Controller**

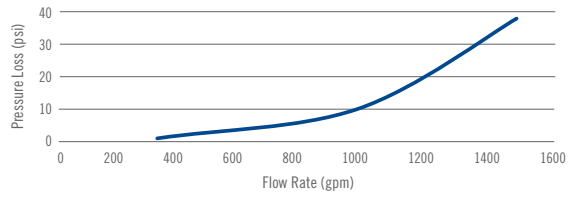

**6 Inch Ratio Controller**

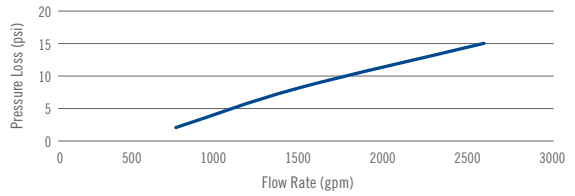

**8 Inch Ratio Controller**

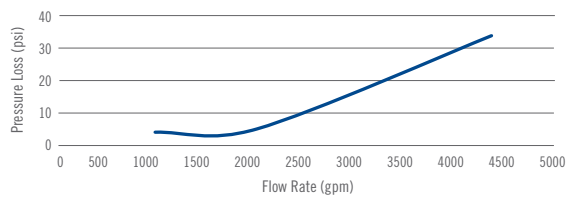



**Pressure Loss Curves**

**FM APPROVED  
NOMINAL FLOW RATES**

**RE-HEALING RF3, 3% FOAM CONCENTRATE**

**3 Inch Ratio Controller**

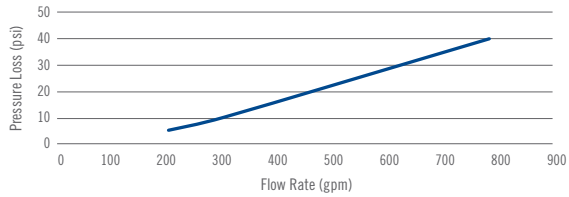

**4 Inch Ratio Controller**

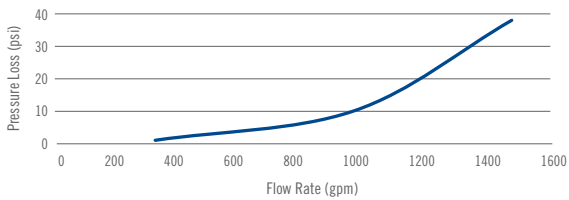

**6 Inch Ratio Controller**

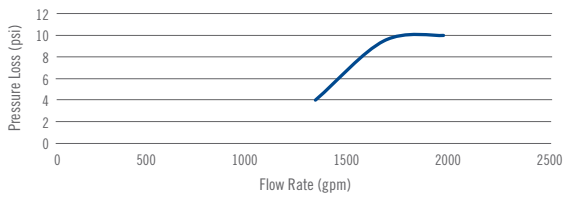

**FM APPROVED  
NOMINAL FLOW RATES**

**ARCTIC™ 3X3% ATC™ FOAM CONCENTRATE**

**3 Inch Ratio Controller**

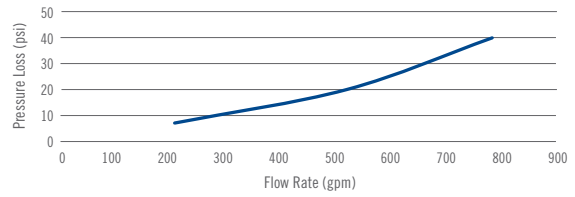

**4 Inch Ratio Controller**

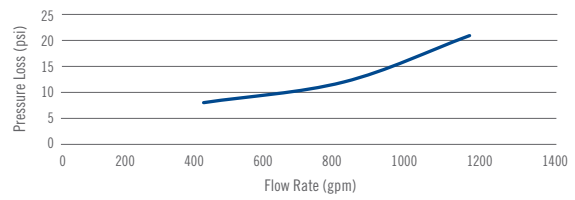

**6 Inch Ratio Controller**

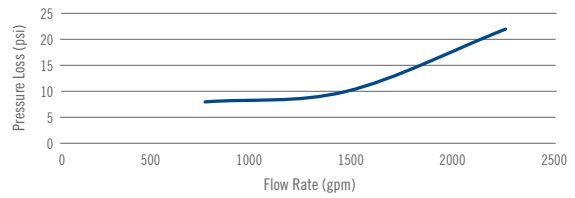

### Ordering Information

RATIO CONTROLLERS / BETWEEN FLANGE		APPROXIMATE SHIPPING WEIGHT	
PART NO.	DESCRIPTION	lb	kg
30104	Ratio Controller - Between Flange, 3.0" (76 mm), RE-HEALING RF3, 3%	10	4
30108	Ratio Controller - Between Flange, 3.0" (76 mm), RE-HEALING RF6, 6%	10	4
30112	Ratio Controller - Between Flange, 3.0" (76 mm), SOLBERG HIGH-EXPANSION	10	4
30120	Ratio Controller - Between Flange, 3.0" (76 mm), ARCTIC 1% SP AFFF	10	4
30121	Ratio Controller - Between Flange, 3.0" (76 mm), ARCTIC 3% AFFF	10	4
30123	Ratio Controller - Between Flange, 3.0" (76 mm), ARCTIC 3% MIL-SPEC AFFF	10	4
30122	Ratio Controller - Between Flange, 3.0" (76 mm), ARCTIC 3x3% ATC	10	4
30105	Ratio Controller - Between Flange, 4.0" (102 mm), RE-HEALING RF3, 3%	16	7
30109	Ratio Controller - Between Flange, 4.0" (102 mm), RE-HEALING RF6, 6%	16	7
30113	Ratio Controller - Between Flange, 4.0" (102 mm), SOLBERG HIGH-EXPANSION	16	7
30130	Ratio Controller - Between Flange, 4.0" (102 mm), ARCTIC 1% AFFF	16	7
30134	Ratio Controller - Between Flange, 4.0" (102 mm), ARCTIC 1% SP AFFF	16	7
30131	Ratio Controller - Between Flange, 4.0" (102 mm), ARCTIC 3% AFFF	16	7
30133	Ratio Controller - Between Flange, 4.0" (102 mm), ARCTIC 3% MIL-SPEC AFFF	16	7
30132	Ratio Controller - Between Flange, 4.0" (102 mm), ARCTIC 3x3% ATC	16	7
30106	Ratio Controller - Between Flange, 6.0" (152 mm), RE-HEALING RF3, 3%	32	14
30110	Ratio Controller - Between Flange, 6.0" (152 mm), RE-HEALING RF6, 6%	32	14
30114	Ratio Controller - Between Flange, 6.0" (152 mm), SOLBERG HIGH-EXPANSION	32	14
30140	Ratio Controller - Between Flange, 6.0" (152 mm), ARCTIC 1% AFFF	32	14
30144	Ratio Controller - Between Flange, 6.0" (152 mm), ARCTIC 1% SP AFFF	32	14
30141	Ratio Controller - Between Flange, 6.0" (152 mm), ARCTIC 3% AFFF	32	14
30143	Ratio Controller - Between Flange, 6.0" (152 mm), ARCTIC 3% MIL-SPEC AFFF	32	14
30142	Ratio Controller - Between Flange, 6.0" (152 mm), ARCTIC 3x3% ATC	32	14
30107	Ratio Controller - Between Flange, 8.0" (203 mm), RE-HEALING RF3, 3%	53	24
30111	Ratio Controller - Between Flange, 8.0" (203 mm), RE-HEALING RF6, 6%	53	24
30115	Ratio Controller - Between Flange, 8.0" (203 mm), SOLBERG HIGH-EXPANSION	53	24
30150	Ratio Controller - Between Flange, 8.0" (203 mm), ARCTIC 1% SP AFFF	53	24
30151	Ratio Controller - Between Flange, 8.0" (203 mm), ARCTIC 3% AFFF	53	24
30153	Ratio Controller - Between Flange, 8.0" (203 mm), ARCTIC 3% MIL-SPEC AFFF	53	24
30152	Ratio Controller - Between Flange, 8.0" (203 mm), ARCTIC 3x3% ATC	53	24





**NOTICE:** Perimeter Solutions makes no representations or warranties as to the completeness or accuracy of the information included herein. The information contained herein is not intended to provide regulatory, legal or expert advice relating to the products, its application or uses. Nothing contained herein is to be construed as a recommendation to use any product, process, equipment or formulation in conflict with any industrial property or intellectual property rights, and Perimeter Solutions makes no representation or warranty, express or implied, that the use thereof will not infringe on any industrial property or intellectual property rights. NO REPRESENTATIONS OR WARRANTIES, EITHER EXPRESSED OR IMPLIED, OF MERCHANTABILITY, FITNESS FOR A PARTICULAR PURPOSE OR OF ANY OTHER NATURE ARE MADE HEREUNDER WITH RESPECT TO THE INFORMATION CONTAINED HEREIN.

[SOLBERGFOAM.COM](http://SOLBERGFOAM.COM)

FORM NUMBER F-2011013-6

COPYRIGHT © 2014. ALL RIGHTS RESERVED.  
SOLBERG, RE-HEALING, ARCTIC AND ATC ARE TRADEMARKS  
OF PERIMETER SOLUTIONS OR ITS AFFILIATES.

**AMERICAS**

PERIMETER SOLUTIONS, LP  
1520 Brookfield Avenue  
Green Bay, WI 54313  
USA  
Tel: +1 920 593 9445

**EMEA**

PERIMETER SOLUTIONS, LP  
Polígono de Baiña, Parcela 23  
33682 Mieres (Asturias)  
Spain  
Tel: +34 985 24 29 45

**ASIA PACIFIC**

PERIMETER SOLUTIONS, LP  
3 Charles Street  
St. Marys NSW 2760  
Australia  
Tel: +61 2 9673 5300