

MANUAL MONITOR - TFT

HARDWARE



Description

The Task Force Tips® PROTECTOR series of manual monitors are ideally suited for high performance fire flows under rugged industrial conditions. The lightweight aluminum alloy is hard coat anodized and powder coated for corrosion protection in even the most hazardous environments. An integrated stainless steel ball shutoff provides visual valve position indicator. Rated flows up to 1250 gpm (4732 l/min).

The PROTECTOR series of monitors remain virtually maintenance free with uniquely integrated polymer wear rings and seals. Stainless components also are integral to the long term rugged durability. The exclusive water way design and internal powder coating provides low loss turbulence free water stream for maximum reach and penetration.

The PROTECTOR series of monitors are matched with TFT's exclusive ZN and ZM fixed flow industrial combination nozzles and provide either a hard hitting

straight stream, or a wide protective fog pattern. Nozzles can be specified with customer required flow and pressure (K-factor) settings and accept low expansion foam attachments designed for maximum reach and foam expansion.



Specifications

Monitor Configuration	Fixed Mount
Flow Rate - Monitors	Flow up to 1250 gpm (4732 l/min)
Operation Energy Source	Manual
Monitor Inlet	3 or 4 inch ANSI 150
Monitor Outlet	2.5 inch (65 mm)
Horizontal Control	Tiller Bar with Lever Action Rotational Lock
Horizontal Movement (degrees)	Continuous 360
Vertical Control	Tiller Bar with Lock Knob
Vertical Movement (degrees)	45 below to 90 above horizontal
Safety Shutoff	With or Without Safety Shutoff
Pressure Relief Valve	No PRV
Valve Design	No Valve
Finish	Powdercoated Fire Engine Red
Certifications	N/A
Sweep Angle (degrees)	Fixed Center
Vertical Oscillation	N/A

SOLBERG is a member of PERIMETER SOLUTIONS, a global producer of leading fire retardant, gel and foam brands with a singular purpose: revolutionize the course of fire suppression technology with safer, more effective and more sustainable solutions. Together, we are Moving Industries Forward by Redefining Fire Suppression. www.solbergfoam.com

Dimensional Information

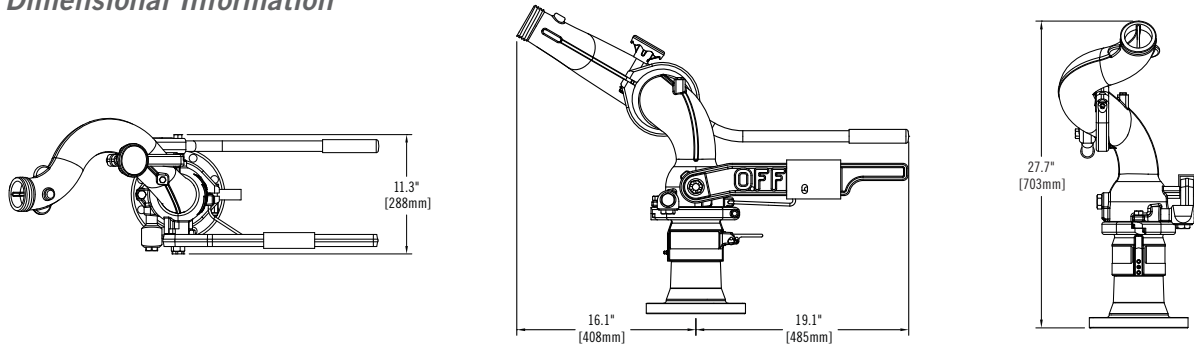

INLET SPECIFICATIONS

FITS FLANGE	OUTSIDE DIAMETER	THICKNESS	BOLT HOLE CIRCLE	NUMBER OF BOLTS	SIZE OF BOLTS
3" ANSI 125/150 - DN80 PN20	7.50" / 190 mm	0.75" / 20 mm	6.00" / 152.5 mm	4	5/8" / M16
4" ANSI 150 - DN100 PN20	9.00" / 230 mm	0.94" / 3 mm	7.5" / 90.5 mm	8	5/8" / M16
DN80 PN16	200 mm	22 mm	160 mm	8	16 mm
DN100 PN16	220 mm	22 mm	180 mm	8	16 mm

Z11A

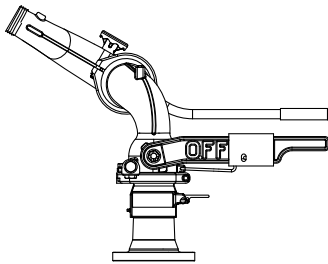

Valve with Threaded Outlet - PROTECTOR monitor with on/off valve and 2.5" (65 mm) threaded outlet. 1250 gpm (4732 l/min) rating.

Z12A

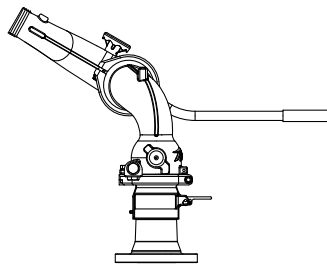

No Valve with Threaded Outlet - PROTECTOR monitor without on/off valve and with 2.5" (65 mm) threaded outlet. 1250 gpm (4732 l/min) rating.

Z11A / Z12A

INLET	OUTLET
1) 3" ANSI 150	1) 2.5" (65 mm) - 7.5 NH
2) 4" ANSI 150	2) 2.5" (65 mm) - 11 BSP
4) DN80 PN16	3) 2.5" (65 mm) - 11.5 NPSH
5) DN100 PN16	9) SPECIAL THREADS

Ordering Information

MANUAL MONITOR

PART NO.	DESCRIPTION	APPROXIMATE SHIPPING WEIGHT	
		lb	kg
32200	Manual Monitor with On/Off Valve, PROTECTOR, 1250 gpm (4732 l/min), 4" inlet mounting flange, 2.5" NH outlet	35	16
32201	Manual Monitor, PROTECTOR, 1250 gpm (4732 l/min), 4" inlet mounting flange, 2.5" NH outlet	35	16
32208	Manual Monitor with On/Off Valve, PROTECTOR, 1250 gpm (4732 l/min), 3" inlet mounting flange, 2.5" NH outlet	35	16
32209	Manual Monitor, PROTECTOR, 1250 gpm (4732 l/min), 3" inlet mounting flange, 2.5" NH outlet	35	16